

Chameleon

C125 Slice

Projector
Wall luminaire
Pole mounted system

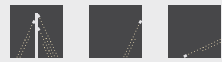

DB 703
Anthracite

ewo
colors



A-Series



E-Series

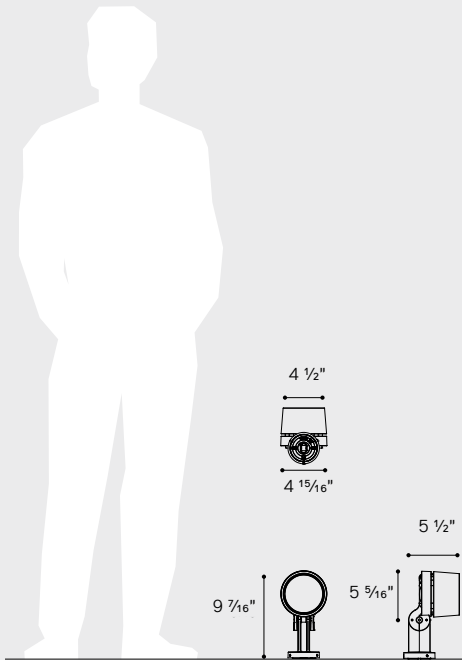

[Check out our online Configurator](#)



IP66 RoHS IK08 UL/CSA

Housing

Housing material	Aluminum die-cast
Housing finish	Polyester powder coating (ewoECP upon request**)
Finish standard colour	RAL 9007, 7015, 9005, 7016, 9007, 9006, 8019, DB703, D2525 Gris 2900
Glass	Safety glass (ESG)
Mounting options	Pole, wall, surface

* other colors on request
** ewo three steps process (high quality alloy, pre-treatment, primer) to ensure extreme corrosion resistance

Measurements

Model	①	②	Weight [lb]
C125	0.13*	0.22*	5.1*
	① projected windage area [ft²]		* without accessories
	② lateral windage area [ft²]		

Operating conditions

Lifetime Visit the [configurator](#) for specific lifetime options

Electrical

	Monochrome		Tunable White				RGBW			
	A-Series	E-Series	Discrete		Internal		Discrete		Internal	
			A-Series	E-Series	A-Series	E-Series	A-Series	E-Series	A-Series	E-Series
Voltage [V], [Hz]										
LED nr.	6	3	-	-	-	12	-	-	-	12
Current max. [mA]	1,000	1,000*	-	-	-	500	-	-	-	550
LED power [W]	18.0	9.0	-	-	-	10.8	-	-	-	19.5
	* 700 for EG06 - 4°									

Driver (external)

	Monochrome	RGBW	Tunable White
Control Options	ON OFF I-10V DALI	DALI DMX	T8 DALI DMX
Programming [optional]	Constant Lumen Output (CLO) Emergency power supply (AC/DC) Stand-alone		
Control accessories	Further accessories on request		
Software	connex light management software for remote management of intelligent luminaire clusters		

Light distributions

Monochrome

Symmetric

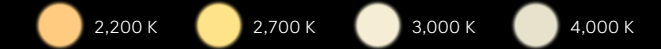
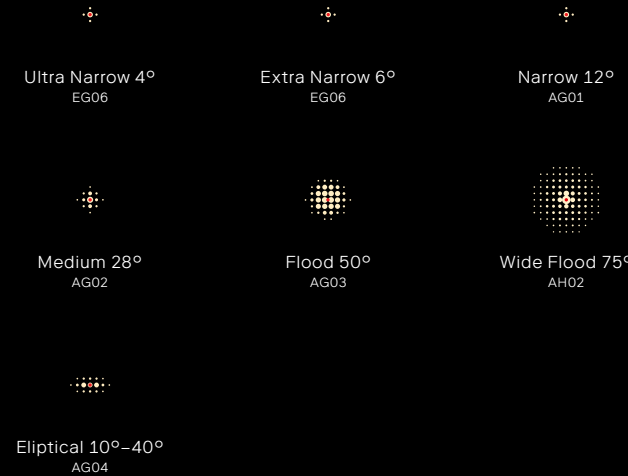

Asymmetric

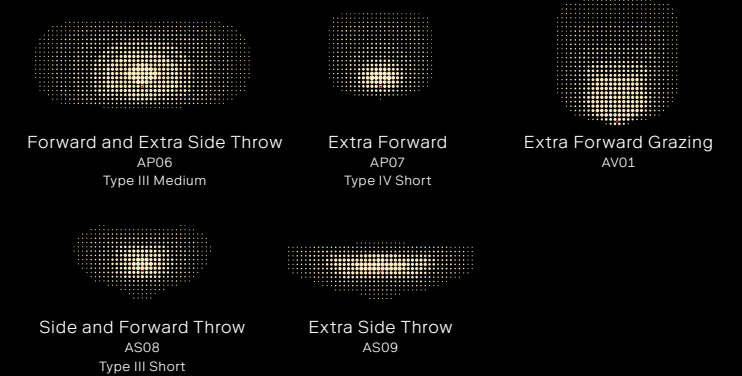

RGBW & TW



Internal colors mixing



EGM: optimal internal mixing

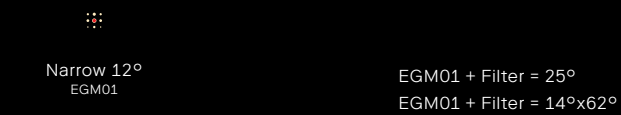

EGX: high performance internal mixing

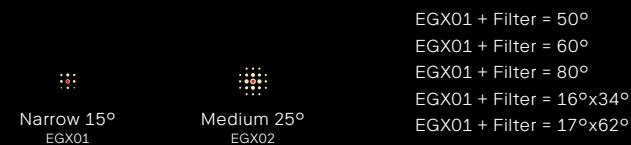

	Monochrome	Tunable White	RGBW
Light colors (K)	4,000	5,000	4,000
CRI*	≥ 80	≥ 80	≥ 80
Distribution	AG01	EGX01 15°	EGX01 15°
BUG Ratings	B3 U0 G0	B1 U0 G0	B-1 U-0 G-0
MacAdam ellipses	≤ 3 SDCM		
Luminous flux [lm]	2,200	1,090	1,200
	* other values on request		

Chameleon C125 Slice



C125S - [] - [] - [] - [] - [] - [] - [] - [] - [] - [] - []

Optic*	Output*	CCT	External Accessory	Decorative Accessory	Internal Accessory	Cable	Finish	Mounting	Control	ECP*
AG01 Symmetric Narrow 12°	350 mA 937lm	22K - 2200K	FS - Full Snoot	FSH - Full Shade	HL - Honeycomb Louver	3FT	RAL7015	WB - Wall Bracket	OO - On/Off	ECP
AG02 Symmetric Medium 27°	400mA 1047lm	27K - 2700K	HS - Half Snoot	SLSH - Slotted Shade	CL - Circular Louver	10FT	RAL7016	SP - Spike	DMX	NoECP
AG03 Symmetric Flood 48°	450mA 1156lm	3K - 3000K	NE - None	ND - None	NI - None	15FT	RAL9005	CB - Connection box	DALI	* Enhanced Corrosion Protection
AG04 Symmetric Elliptical 10-40°	500mA 1264lm	4K - 4000K				CUS - Custom	RAL9006	PA - Pole adaptor	0-10V	
AH02 Symmetric Wide Flood 75°	550 mA 1370lm	TW - Tunable White					RAL9007			
AP06 Asymmetric Forward and Extra Side Throw	600mA 1476lm	RGBW					RAL____			
AP07 Asymmetric Extra Forward	650mA 1580lm									
AS08 Asymmetric Side and Forward Throw	700mA 1684lm									
AV01 Asymmetric Extra Forward Grazing	750mA 1774lm									
AS09 Extra Side Throw	800mA 1864lm									
EG06-4 Symmetric Narrow 4°	850mA 1952lm									
EG06-6 Symmetric Narrow 6°	900mA 2040lm									
EGM01 Narrow 12°	950mA 2127lm									
EGX01 Narrow 15°	1000mA 2213lm									
EGX02 Narrow 15°										

* Lumens based on AG01 optic and 4000K CCT
 * Other outputs on request

* A-series not for RGBW/TW

External accessories

Shadow Sail

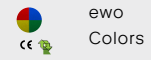
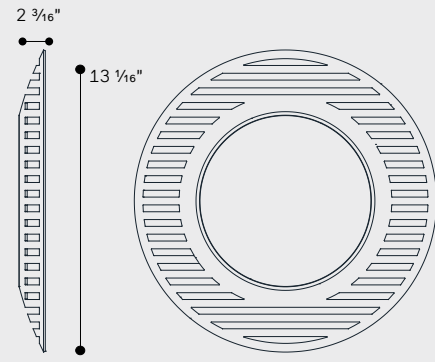

Transparent Snoot

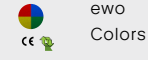
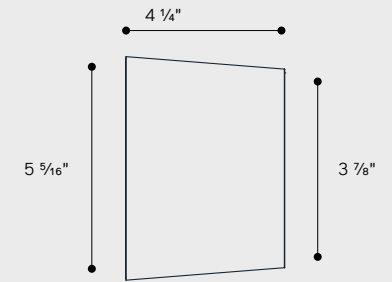
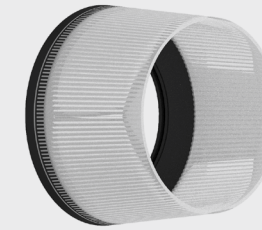

Heritage Sail

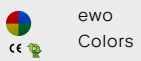
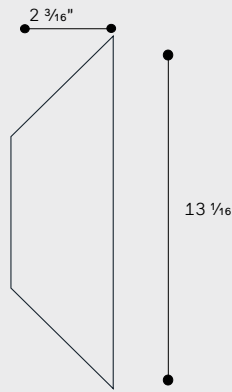
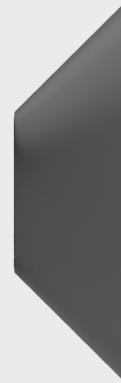

Support for scenic Filters

For custom C125 accessories, please contact ewo USA

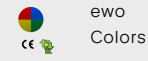
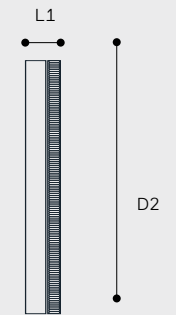
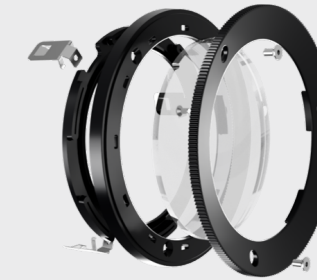

Snoot

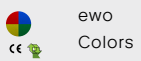
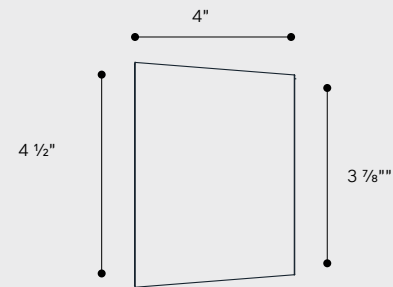
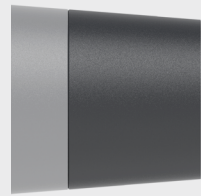

Half Snoot

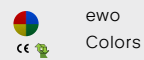
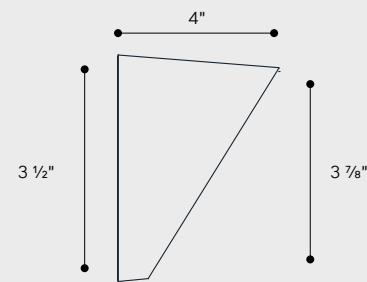
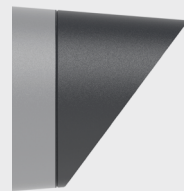

Internal accessories

Honeycomb Louver



ewo Colors

Mounting accessories

Wall Hinge

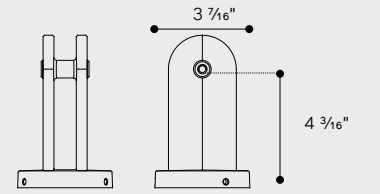
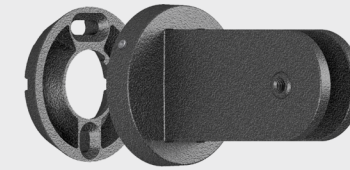

ewo Colors

Circular Louver

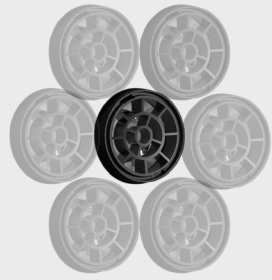

ewo Colors

V-Notch

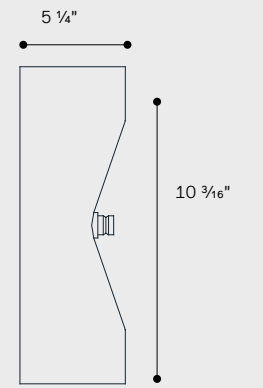

ewo Colors

Pole adaptor

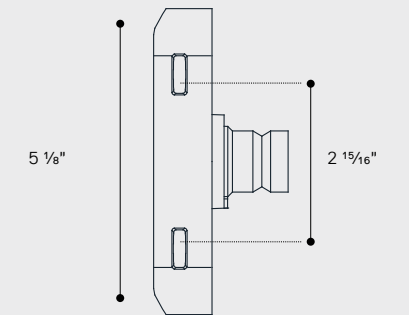
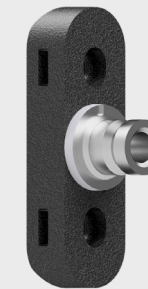

ewo Colors

Catenary

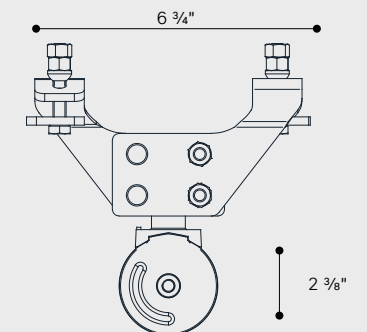
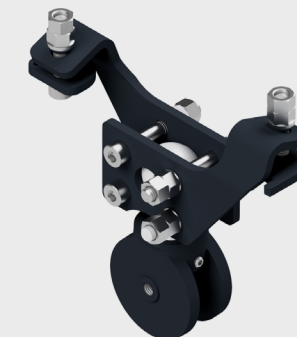

ewo Colors

Mounting accessories

Connection box

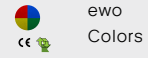
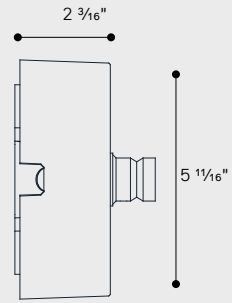
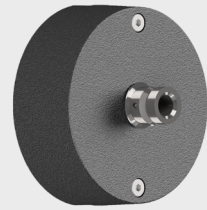

Single pole adapter

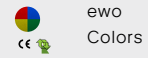
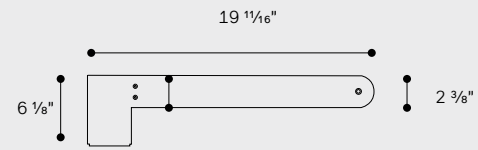
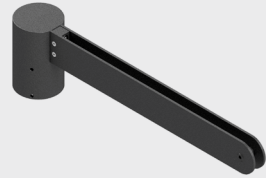

Double pole adapter

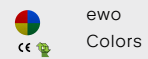
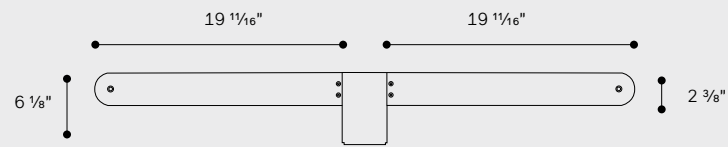
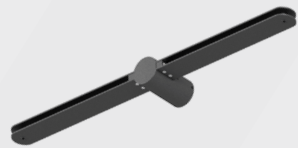

Ground spike

