

Chameleon

C165 Integral

Projector
Wall luminaire
Pole mounted system

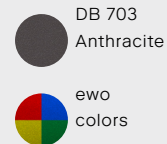

A-Series



E-Series

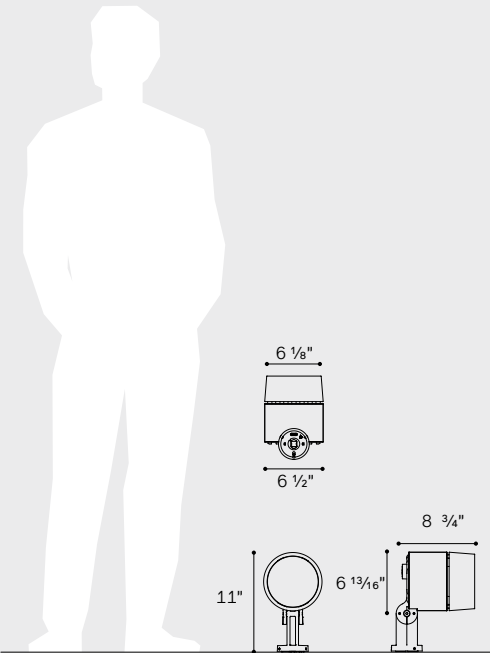

[Check out our online Configurator](#)



IP66 RoHS IK08 UL/CSA

Housing

Housing material	Aluminum die-cast
Housing finish	Polyester powder coating (ewoECP upon request**)
Finish standard colors	RAL 9007, 7015, 9005, 7016, 9007, 9006, 8019, DB703, D2525 Gris 2900
Glass	Safety glass (ESG)
Mounting options	Pole, wall, surface
	* other colors on request
	** ewo three steps process (high quality alloy, pre-treatment, primer) to ensure extreme corrosion resistance

Measurements

Model	①	②	Weight [lb]
C165	0.32*	0.42*	8.6*
	① projected windage area [ft²]		* without accessories
	② lateral windage area [ft²]		

Operating conditions

Lifetime	Visit the configurator for specific lifetime options
----------	--

Electrical

	Monochrome		Tunable White				RGBW			
	A-Series	E-Series	A-Series	E-Series	A-Series	E-Series	A-Series	E-Series	A-Series	E-Series
Voltage [V], [Hz]	120-277v, 50/60		120-277v, 50/60		120-277v, 50/60		120-277v, 50/60		120-277v, 50/60	
LED nr.	12	7	12	-	-	28	12	-	-	28
Current max. [mA]	800	1,050*	560	-	-	435	600	-	-	250
Power max. [W]	31.1	22.9	11.5	-	-	21.8	23.3	-	-	23.1

* 700 for EG06 - 4°

Driver (external)

	Monochrome	RGBW	Tunable White
Control Options	ON OFF 1-10V DALI	DALI DMX	T8 DALI DMX
Programming [optional]	Constant Lumen Output (CLO) Emergency power supply (AC/DC) Stand-alone		
Control accessories	Further accessories on request		
Software	connexx light management software for remote management of intelligent luminaire clusters		

Light distributions

Monochrome

Symmetric

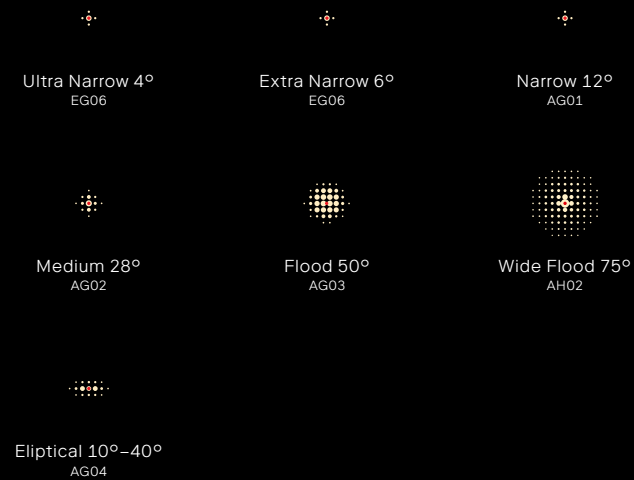

Asymmetric

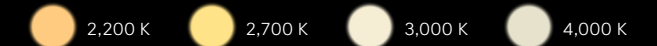
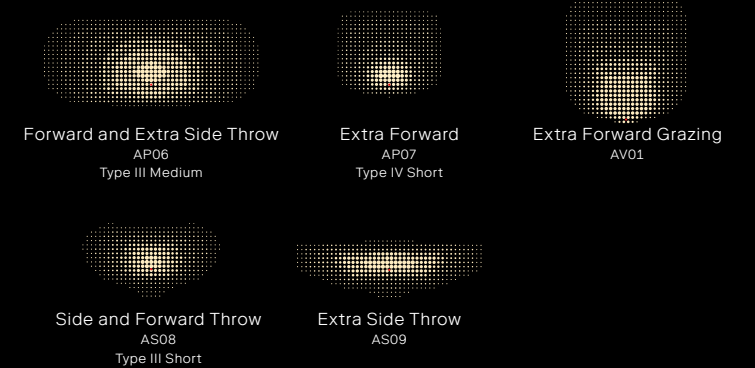

RGBW & TW



Internal colors mixing



EGM: optimal internal mixing

Discrete colors mixing



Asymmetric

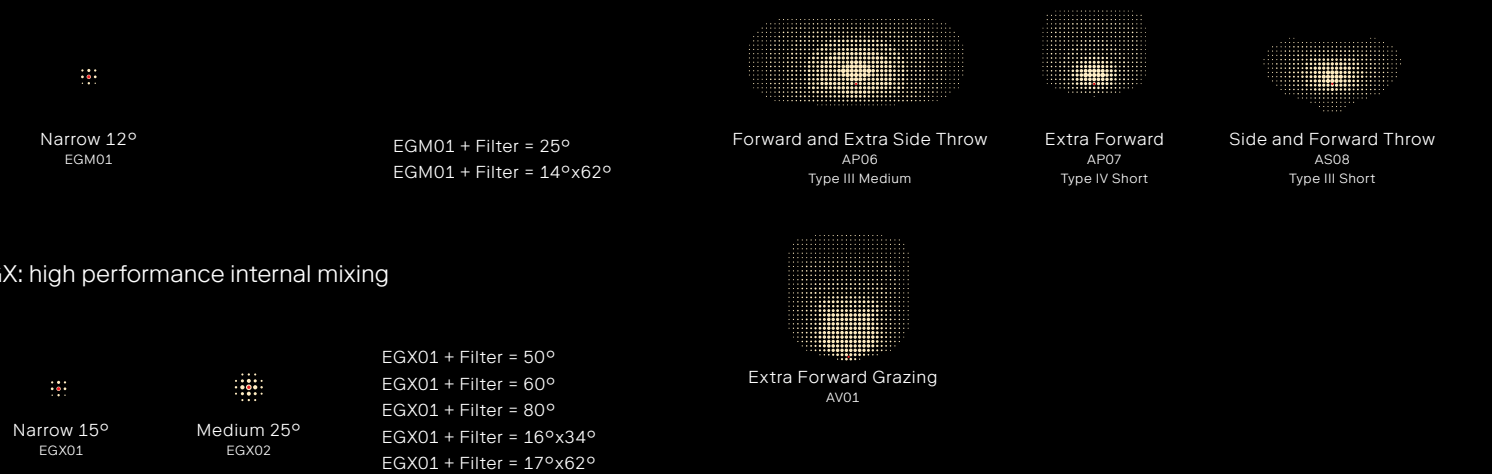

EGX: high performance internal mixing

	Monochrome		Tunable White		RGBW	
Light colors (K)	4,000		5,000		4,000	
CRI*	≥ 80		≥ 80		≥ 80	
Distribution	AG01	EG06 6°	AS08	EGX01 15°	AV01	EGX01 15°
BUG Ratings	B3 U0 G0	B3 U0 G0	B2 U0 G1	B2 U0 G0	B2 U0 G1	B2 U0 G0
MacAdam ellipses	≤ 3 SDCM		≤ 3 SDCM		≤ 3 SDCM	
Luminous flux [lm]	3,730	2,640	1,100	2,100	885	1,580

* other values on request

Chameleon C165 Integral



Optic*	Output*	CCT	External Accessory	Decorative Accessory	Internal Accessory	Cable	Finish	Mounting	Control	ECP*
AG01 Symmetric Narrow 12°	350 mA 1873lm	22K - 2200K	FS - Full Snoot	FSH - Full Shade	HL - Honeycomb Louver	3FT	RAL7015	WB - Wall Bracket	OO - On/Off	ECP
AG02 Symmetric Medium 27°	400mA 2095lm	27K - 2700K	HS - Half Snoot	SLSH - Slotted Shade	CL - Circular Louver	10FT	RAL7016	SP - Spike	DMX	NoECP
AG03 Symmetric Flood 48°	450mA 2313lm	3K - 3000K	NE - None	ND - None	NI - None	15FT	RAL9005	CB - Connection box	DALI	* Enhanced Corrosion Protection
AG04 Symmetric Elliptical 10-40°	500mA 2519lm	4K - 4000K				CUS - Custom	RAL9006	PA - Pole adaptor	0-10V	
AH02 Symmetric Wide Flood 75°	550 mA 2741lm	TW - Tunable White					RAL9007			
AP06 Asymmetric Forward and Extra Side Throw	600mA 2952lm	RGBW					RAL____			
AP07 Asymmetric Extra Forward	650mA 3161lm									
AS08 Asymmetric Side and Forward Throw	700mA 3367lm									
AV01 Asymmetric Extra Forward Grazing	750mA 3548lm									
AS09 Extra Side Throw	800mA 3728lm									
EG06-4 Symmetric Narrow 4°	850mA 3905lm									
EG06-6 Symmetric Narrow 6°	900mA 4080lm									
EGM01 Narrow 12°										
EGX01 Narrow 15°										
EGX02 Narrow 15°										

* Lumens based on AG01 optic and 4000K CCT
 * Other outputs on request

* A-series not for RGBW/TW

External accessories

Shadow Sail

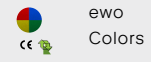
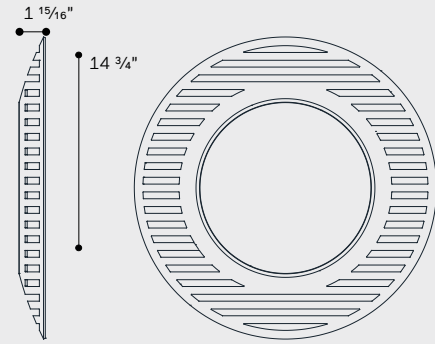

Transparent Snoot

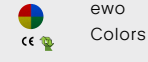
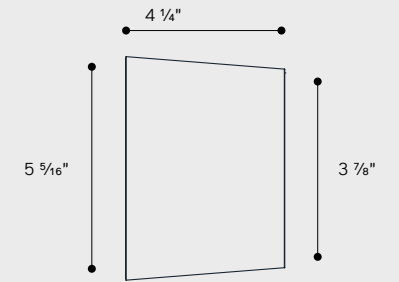
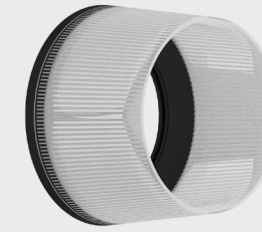

Heritage Sail

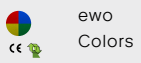
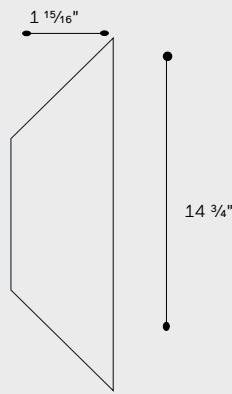
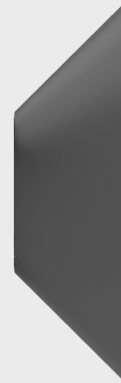

Support for scenic Filters

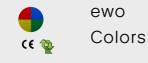
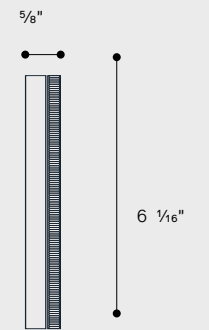
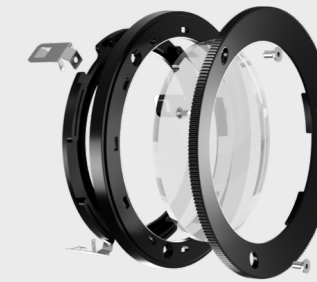

Snoot

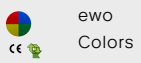
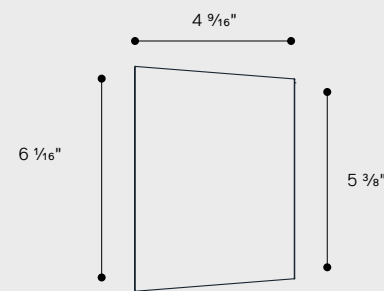
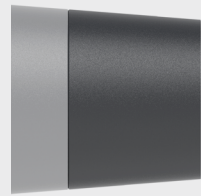

Half Snoot

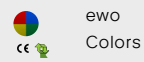
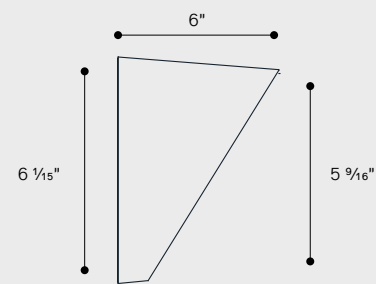
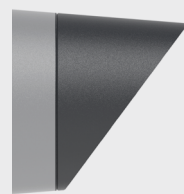

Internal accessories

Honeycomb louver

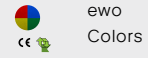

Circular louver

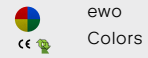
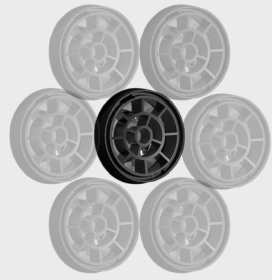

Mounting accessories

Wall Hinge

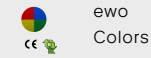
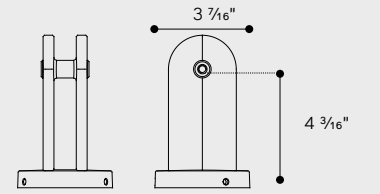
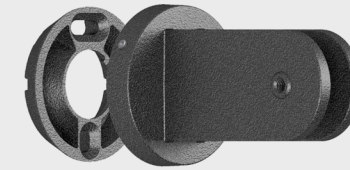

V-Notch

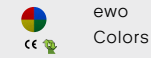
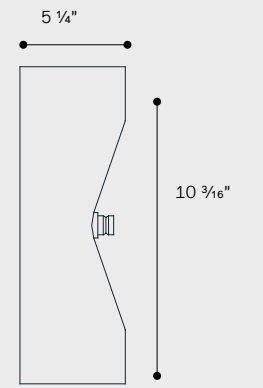

Pole adaptor

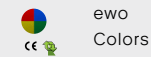
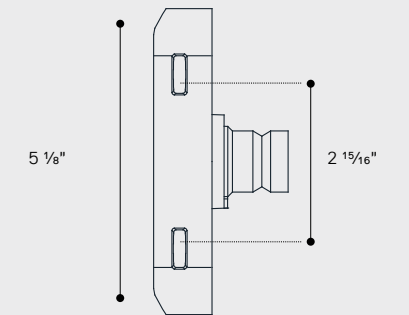

Catenary

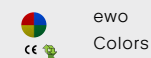
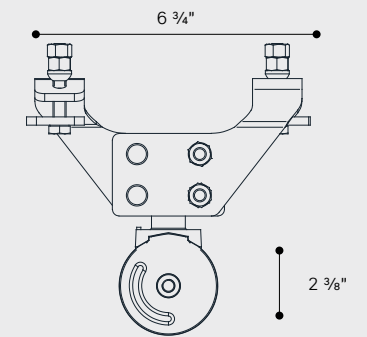
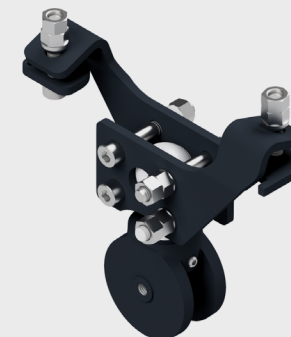

Mounting accessories

Connection box

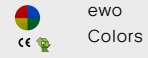
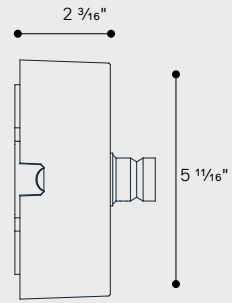
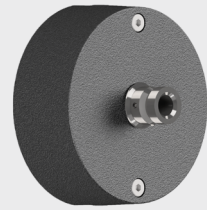

Single pole adapter

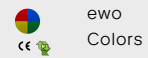
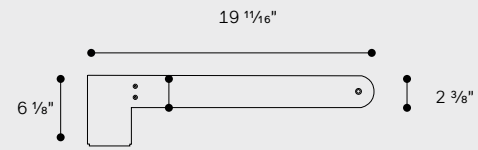
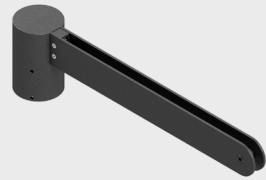

Double pole adapter

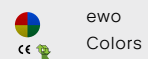
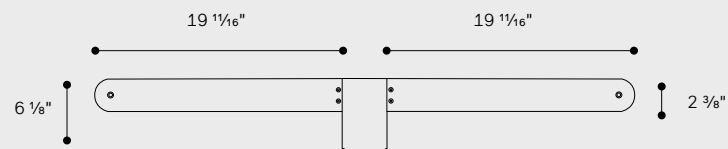
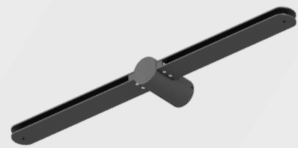

Ground spike

