

Chameleon

C165 Slice

Projector
Wall luminaire
Pole mounted system

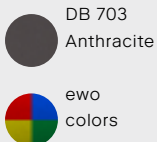

A-Series



E-Series

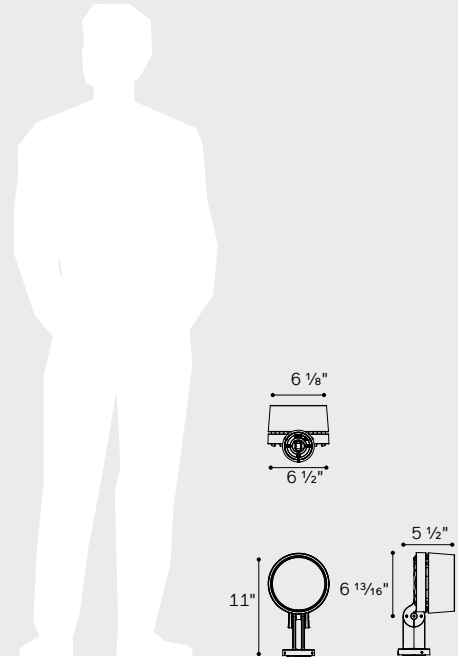

[Check out our online Configurator](#)



IP66 RoHS IK08 UL/CSA

Housing

Housing material	Aluminum die-cast
Housing finish	Polyester powder coating (ewoECP upon request**)
Finish standard colors	RAL 9007, 7015, 9005, 7016, 9007, 9006, 8019, DB703, D2525 Gris 2900
Glass	Safety glass (ESG)
Mounting options	Pole, wall, surface

** ewo three steps process (high quality alloy, pre-treatment, primer) to ensure extreme corrosion resistance

Measurements

Model	1" @	-1" @	Weight [lb]
C165	0.18*	0.27*	7.3*
	① projected windage area [ft²]		* without accessories
	② lateral windage area [ft²]		

Operating conditions

Lifetime	Visit the configurator for specific lifetime options
----------	--

Electrical

	Monochrome		Tunable White				RGBW			
	A-Series	E-Series	Discrete		Internal		Discrete		Internal	
	A-Series	E-Series	A-Series	E-Series	A-Series	E-Series	A-Series	E-Series	A-Series	E-Series
Voltage [V], [Hz]										
LED nr.	12	7	12	-	-	28	12	-	-	28
Current max. [mA]	900	1,050*	830	-	-	500	900	-	-	450
LED power [W]	32.4	21.0	17.4	-	-	24.7	31.9	-	-	36.9

* 700 for EG06 - 4°

Driver (external)

	Monochrome	RGBW	Tunable White
Control Options	ON OFF 1-10V DALI	DALI DMX	T8 DALI DMX
Programming [optional]	Constant Lumen Output (CLO) Emergency power supply (AC/DC) Stand-alone		
Control accessories	Further accessories on request		
Software	connex light management software for remote management of intelligent luminaire clusters		

Light distributions

Monochrome

Symmetric

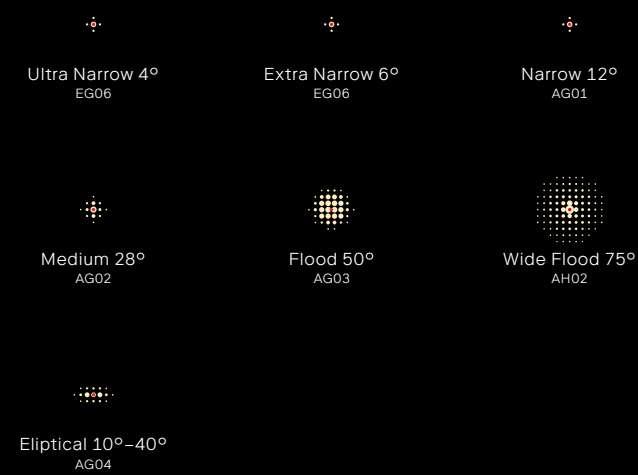

Asymmetric

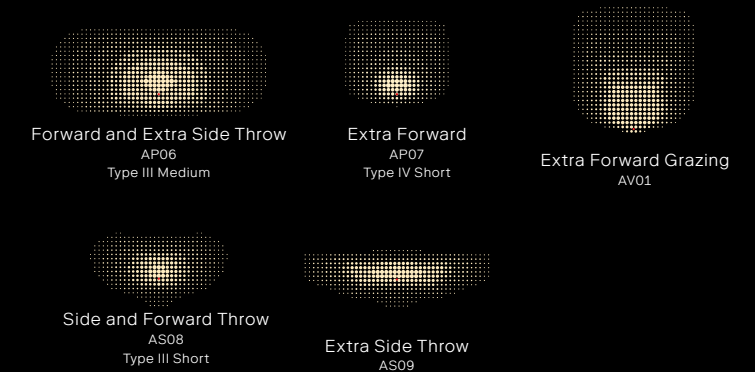

RGBW & TW

Internal colors mixing



EGM: optimal internal mixing

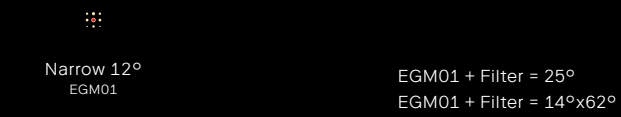

Discrete colors mixing



Asymmetric



EGX: high performance internal mixing

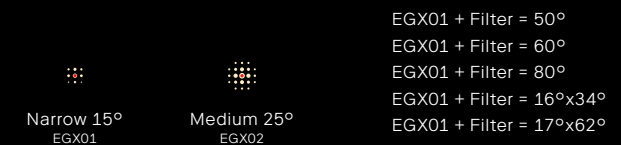

	Monochrome		Tunable White		RGBW	
	4,000		5,000		4,000	
Light colors (K)	4,000		5,000		4,000	
CRI*	≥ 80		≥ 80		≥ 80	
Distribution	AG01	EG06 6°	AV01	EGX01 15°	AV01	EGX01 15°
BUG Ratings	B3 U0 G0	B3 U0 G0	B2 U0 G1	B2 U0 G0	B2 U0 G1	B2 U0 G0
MacAdam ellipses	≤ 3 SDCM		≤ 3 SDCM		≤ 3 SDCM	
Luminous flux [lm]	4,080	2,640	1,500	2,300	1,140	2,460

* other values on request

Chameleon

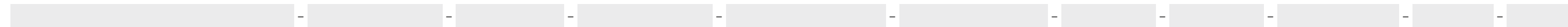

Optic*	Output*	CCT	External Accessory	Decorative Accessory	Internal Accessory	Cable	Finish	Mounting	Control	ECP*
AG01 Symmetric Narrow 12°	350 mA 1873lm	2200K	Full Snoot	Full Shade	Honeycomb Louver	3 ft cable	RAL 7015	Wall Bracket	On/Off	Yes
AG02 Symmetric Medium 27°	400mA 2095lm	2700K	Half Snoot	Slotted Shade	Circular Louver	10 ft cable	RAL 7016	Spike	DMX	No
AG03 Symmetric Flood 48°	450mA 2313lm	3000K	None		None	15 ft cable	RAL 9005	Connection box	DALI	* Enhanced Corrosion Protection
AG04 Symmetric Elliptical 10-40°	500mA 2519lm	4000K				Other	RAL 9006	Pole adaptor	0-10V	
AH02 Symmetric Wide Flood 60°	550 mA 2741lm	Tunable White					RAL 9007			
AP06 Asymmetric Forward and Extra Side Throw 27°	600mA 2952lm	RGBW					RAL ____			
AP07 Asymmetric Extra Forward	650mA 3161lm									
AS07 Asymmetric Side Throw	700mA 3367lm									
AS08 Asymmetric Side and Forward Throw	750mA 3548lm									
AV01 Asymmetric Extra Forward Grazing	800mA 3728lm									
EG06 Symmetric Narrow 4°	850mA 3905lm									
EGM01 Symmetric Narrow 12°	900mA 4080lm									
EG06 Symmetric Narrow 6°										
EGM01 Symmetric Medium 25°										
EGM01 Symmetric Elliptical 14-62°										
EGX01 Narrow 15°										
EGX02 Medium 25°										

* Lumens based on AG01 optic and 4000K CCT
 * Other outputs on request

* A-series not for RGBW/TW

External accessories

Shadow Sail

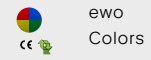
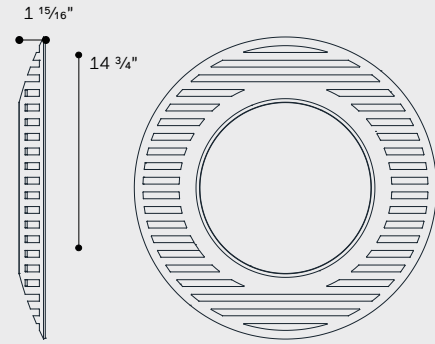

Transparent Snoot

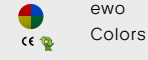
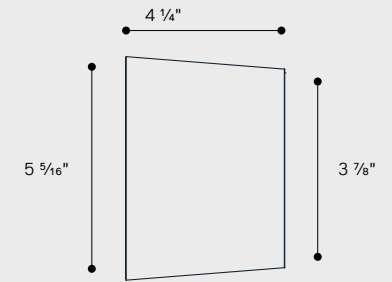
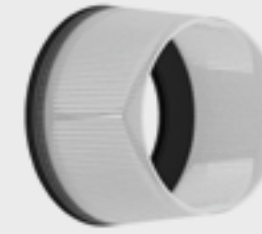

Heritage Sail

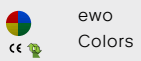

Support for scenic Filters

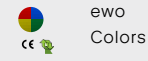
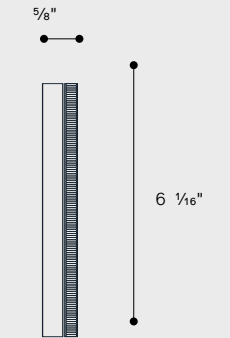

Snoot

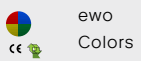
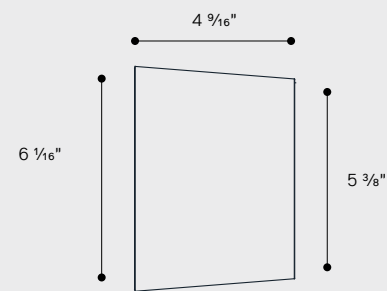
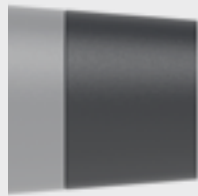

Half Snoot

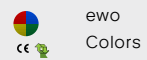
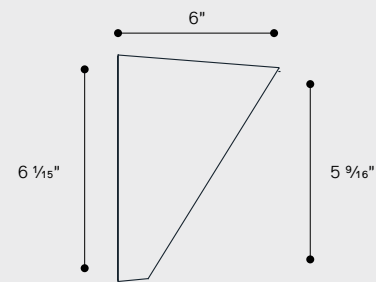

Internal accessories

Honeycomb louver



ewo
Colors

Circular louver



ewo
Colors

Mounting accessories

Wall Hinge

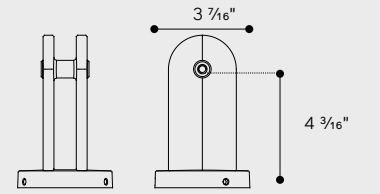

ewo
Colors

V-Notch

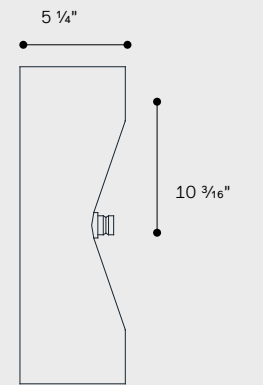

ewo
Colors

Pole adaptor

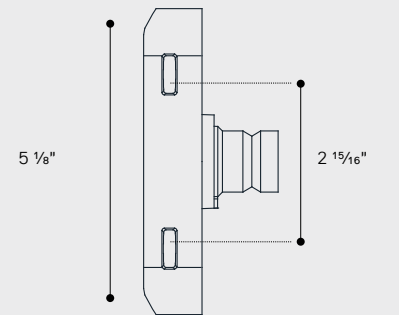

ewo
Colors

Catenary

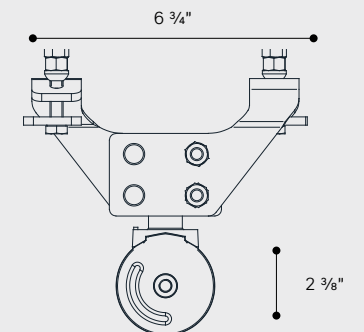

ewo
Colors

Mounting accessories

Connection box

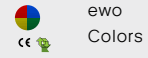
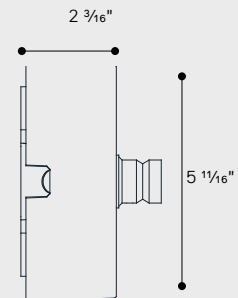

Single pole adapter

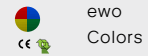
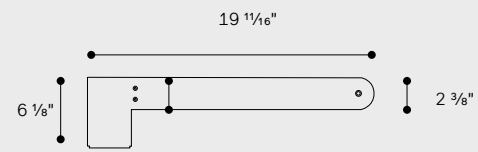

Double pole adapter

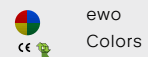
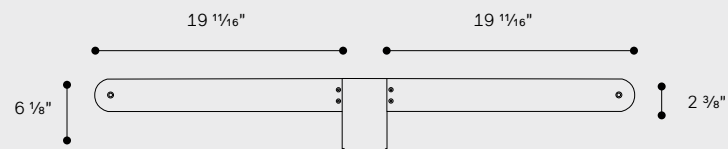

Ground spike

